



**Thank you for purchasing the X ROCKER!
We know you will enjoy your X Rocker experience
as much as we do.**

**Welcome to the world of interactive audio. With
your new X Rocker you can now not only hear
your music but actually FEEL it. Whether you are
listening to music, watching a movie, or playing
a game, you will become a part of it.**

Get ready to experience sound as you never have!

IMPORTANT: You must keep your original retail receipt as proof of purchase.

**Need Help? Email: service@acebayou.com Web: www.thexrocker.com
Phone: 1 931 359 2603, In Europe, call +44 (0)845 468 0262**

Please have this item number ready when contacting Customer Service: #51368

XRocker™

don't just sit there. start *rocking!*

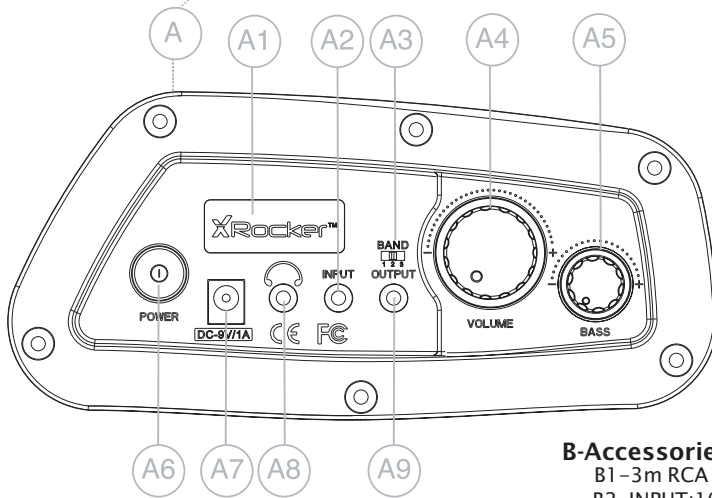

FEATURES

A-Control Panel

- A1-Power Indicator Light
- A2-Audio Input Jack
- A3-Wireless Band Switch
- A4-Volume Adjustment
- A5-Bass Volume Adjustment
- A6-Power On/Off Switch
- A7-9V DC Power Input Jack
- A8-Headphone Jack
- A9-Audio Output Jack
- A10-DC 3V/200mA Power Input Jack of TX
- A11-Audio Input Jack of TX
- A12-Power On/Off Switch of TX
- A13-Wireless Band Switch of TX

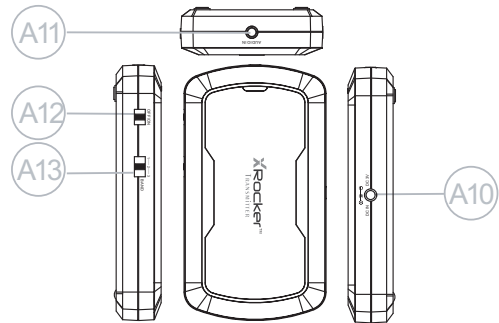

B-Accessories Supplied

- B1-3m RCA Stereo male to 3.5mm stereo male cable (1 PC)
- B2-INPUT:100-240V AC 50/60Hz
OUTPUT:9V DC 1000mA 9W Main POWER Adapter.
- B3-RCA female to female barrel adapter (2 PCS)
- B4-0.15m RCA stereo female to 3.5mm stereo male cable (1PC)
- B5-TX Box
- B6-0.15m RCA stereo male to 3.5mm stereo male cable (1PC)
- B7-3.5mm stereo male to 3.5mm stereo male cable (1PC)

C-Audio Specifications:

- I .The unit specifications:
 - Signal-to-Noise Ratio(Amplifier):Subwoofer:>50dB Satellite:>60dB
 - Frequency Response: 60Hz~15kHz
 - Distortion: Subwoofer: <4% (F=100Hz) Satellite:<1% (F=1kHz)
 - Input: DC 9V/1A
- II .TX / RX specification:
 - 1) TX Power supply 3V DC/200mA
2XAAA Batteries (BATTERIES ARE NOT INCLUDED)
 - 2) TX Current: 40mA
 - 3) RX Current: 20mA
 - 4) TX Transmission distance: < 65.6 ft / 20 meters (No buildings or other barriers)
 - 5) Environmental temperature: 14°F~158°F / -10°C~70°C
 - 6) Modulation mode: FSK
 - 7) TX Work frequency: 863.3, 863.9,864.55 MHZ
 - 8) RX Work frequency: 863.3, 863.9,864.55 MHZ
 - 9) TX Power: <10dBm
 - 10) RX Sensitivity:-100dBm
 - 11) RX frequency range: 50Hz~13KHz
 - 12) Second harmonic suppression: -40dB
 - 13) Band quantity: 3 channels

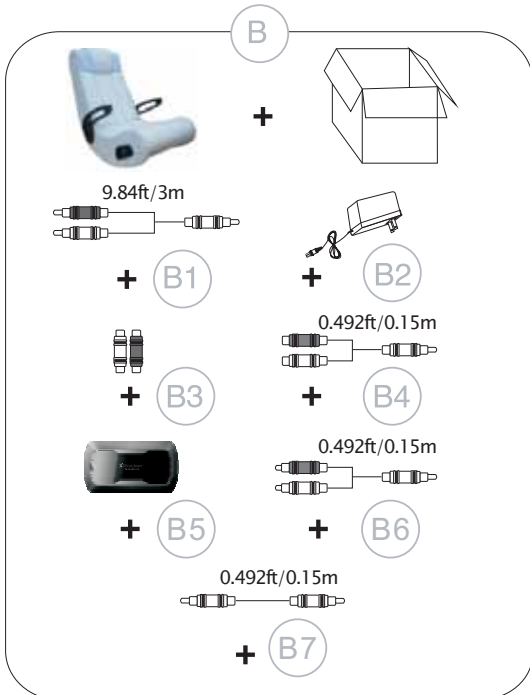

*SOME PARTS MAY VARY SLIGHTLY

Need Help? Email: service@acebayou.com Web: www.thexrocker.com
Phone: 1 931 359 2603, In Europe, call +44 (0)845 468 0262

FUNCTIONS:









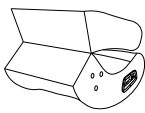

- Foldable construction for ease of storage and portability.
- Side control panel with volume, bass control, input/output jacks, and band switch.
- Ergonomic design with full back support.
- Easy to clean heavy duty upholstery grade vinyl cover.
- Wireless audio transmission

READ BEFORE USAGE:

- Always make sure hinge is locked before moving.
- Always make sure hinge is locked before sitting in the chair.
- Excessive use of audio equipment could lead to hearing loss.
- Excessive sound pressure from earphones and headphones can cause hearing loss.
- Children under the age of 13 should not use this product without adult supervision.
- Strictly for indoor use. Do not expose to direct sunlight, moisture or extreme temperatures.
- If the cover becomes wet, disconnect the power immediately and don't use until it is completely dry.
- Do not attempt to remove the cover or any components. Removal of the cover or tampering with components puts you at risk for injury or death from electrical shock.
- When using in wire mode, please keep the band to "OFF" (A3).
- The maximum input of the TX box is 1V. If the input is over 1V, the sound can become distorted or fuzzy. If the Sound coming out of the chair is fuzzy at low volumes, lower the volume on the audio source (ex. The TV, Mp3, etc) and the distortion should go away.
- Do not mix alkaline, standard carbon-zinc, or rechargeable Ni-cad, NiMH, etc.
- Do not mix old and new batteries.

SET UP:

1. Lift X Rocker out of box .
2. Keep the chair in the folded position and place it on the floor so that back side of the chair is facing up and the bottom of the seat is touching the floor.
3. Review the set up diagrams to familiarize yourself with the X Rocker's components, accessories, and set-up.
4. Please complete 1-4 to assemble the chair.
5. When used in wireless mode, make sure that the control panel is not more than 65.6ft / 20 meters from the audio source and 6.5ft / 2 meters from a power source.
6. Unpack the power adapter and connect it to the main power outlet, then to the power jack on the control panel. (A7)
7. Press the power button (A6) and confirm that the power indicator light (A1) is on. In wireless mode, turn on the power to the TX box (A12), confirm that its indicator light is on, and check that the band selected on the TX box (A13) is the same as that selected on the control panel (A3) of the X Rocker.
8. Follow the connection diagrams. They show how to connect the X Rocker to the audio source of your choice .
9. Adjust the bass and volume levels to your preference---start rocking.

1	2	6	6	2	2	6	2	1	1
									
A	B	C	D	E	F	G	H	I	J

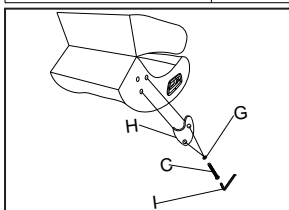

Step1: Place the arm bracket(H) on the right side of the chair. Please pay careful attention to the drawing to be sure you have the correct arm bracket for that side. Use 2bolts© with washer (G)to fasten the arm bracket to the side of the chair .Tighten the bolts with the Allen wrench provided(I).

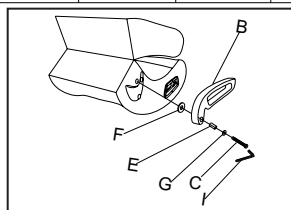

Step2: Attach the right arm to the chair using the parts shown in the illustration. The metal sleeve will position itself inside the arm hole and the large washer(F)should be between the arm and the chair. Tighten the bolts with the Allen wrench provided(I). When assembled correctly the arm should pivot freely.

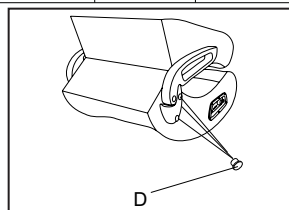

Step3: Push the plastic caps(D)into the bolts holes to finish the arm assembly for that side. Repeat steps 1-3 for the left side of the chair.

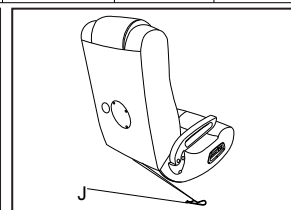

Step4: Insert pin(J)into closure

WIRE MODE CONNECTION GUIDE

DIAGRAM 1 XBOX™, XBOX 360™, PLAYSTATION 3™ & Wii

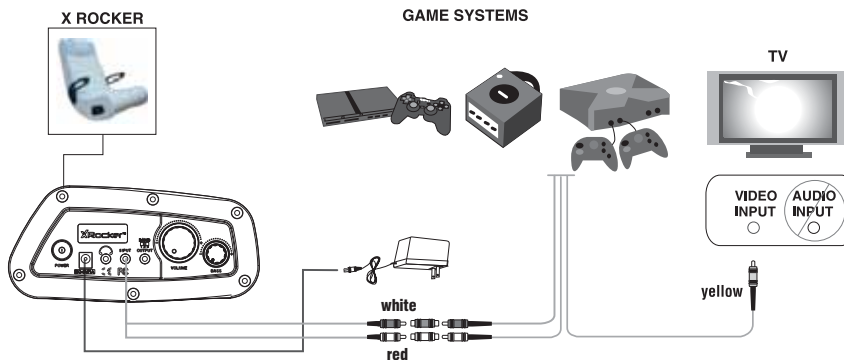

DIAGRAM 2 HOME THEATER & SATELLITE

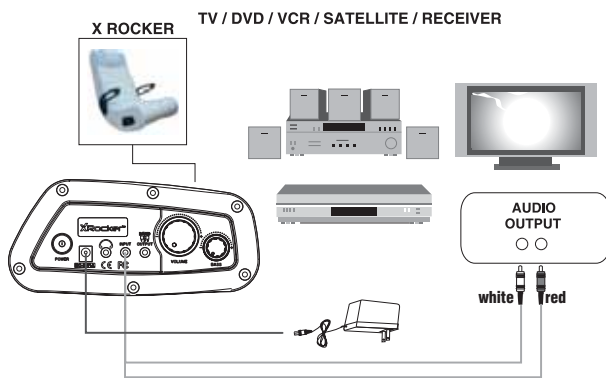

DIAGRAM 3 PORTABLE DEVICES

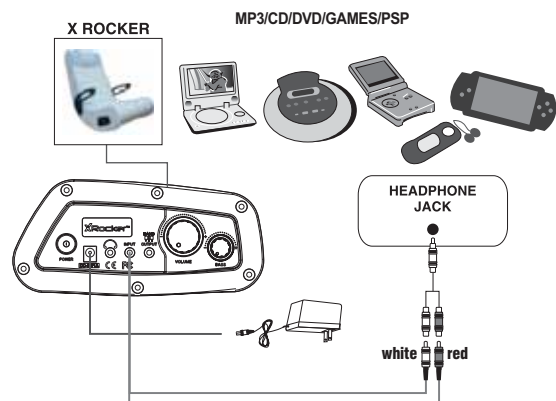
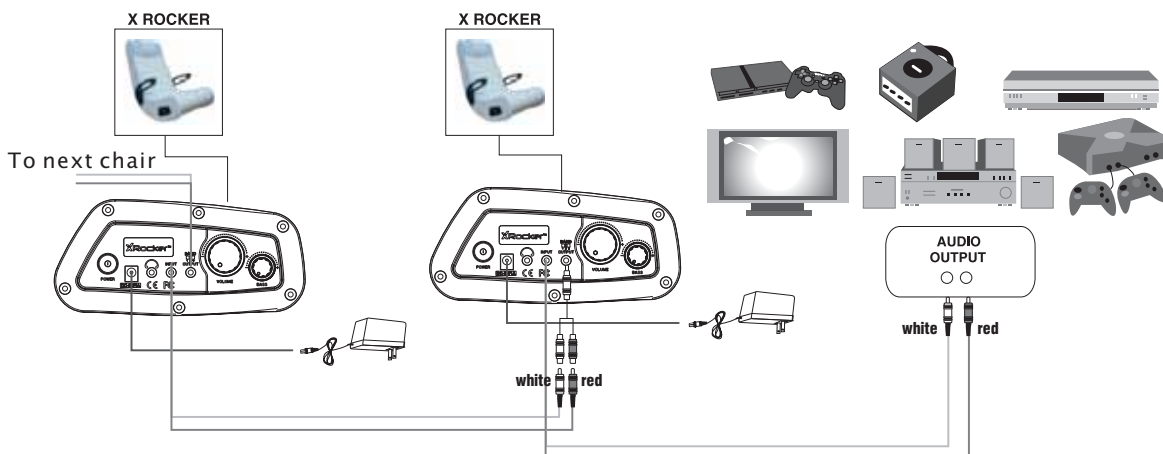

DIAGRAM 4 MULTI-USER CONNECTION



Need Help? Email: service@acebayou.com Web: www.thexrocker.com
 Phone: 1 931 359 2603, In Europe, call +44 (0)845 468 0262

WIRELESS MODE CONNECTION GUIDE

DIAGRAM 1 XBOX™, XBOX 360™, PLAYSTATION 3™ & Wii

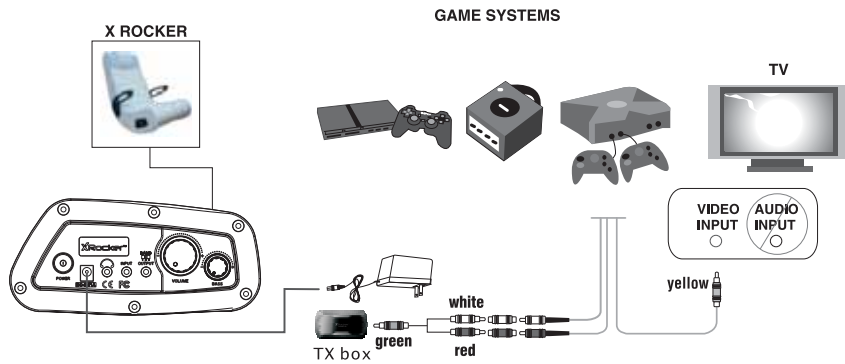

DIAGRAM 2 HOME THEATER & SATELLITE

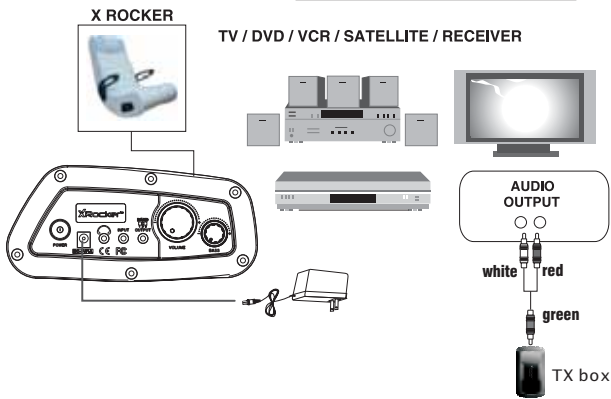

DIAGRAM 3 PORTABLE DEVICES

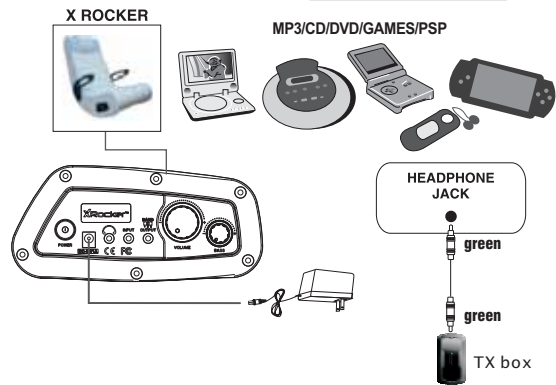
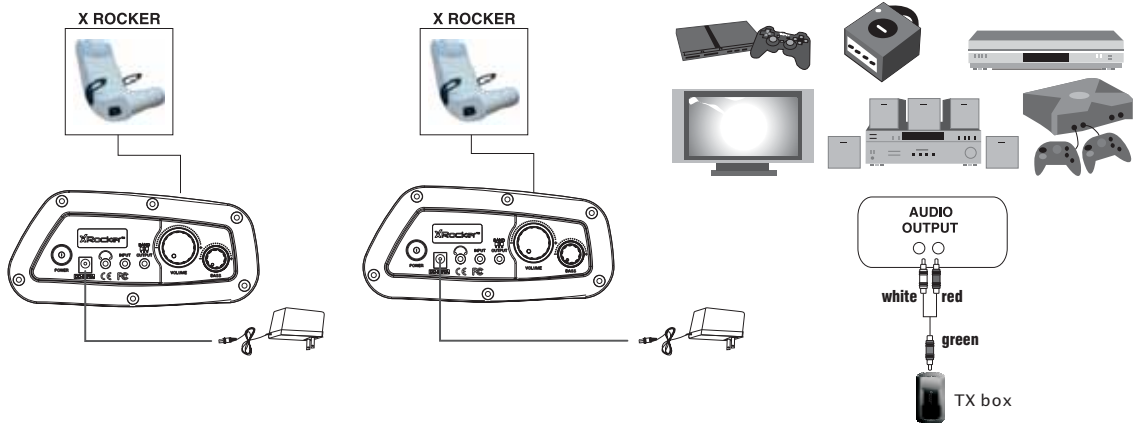

DIAGRAM 4 MULTI-USER CONNECTION



Need Help? Email: service@acebayou.com Web: www.thexrocker.com
 Phone: 1 931 359 2603, In Europe, call +44 (0)845 468 0262

Wired Connection

Direct connection to game console

If you use component or AV cable to connect console to TV:



Fit the B3 connectors to the ends of the B1 cable

Unplug the Red and White plugs of the console's AV cable from the TV, leaving the Yellow (video) plug in place.

Plug the Red and White plugs of the console's AV cable into the B3 connectors on the Rocker's B1 cable.

Component or AV cables are supplied with new models of PlayStation 3, X Box Elite and Wii, as well as earlier generation consoles.

If you use HDMI cable to connect to TV

Connect Rocker to one of TV's Audio Out connections. Most HD-ready TV sets have some combination of RCA, mini-plug or optical audio interfaces enabling audio connection to accessories. Many have all three.



RCA connection is direct to the RCA plug terminations of the Rocker's B1 cable, but make sure you are connecting to an Audio Out pair. If your TV has only two RCA sockets and they are not marked Audio Out, they are probably input sockets and cannot send audio information to the Rocker.

Mini Plug connection. Mini Plug sockets are often found on the front or side of the TV set, marked with the headset icon². Fit the RCA-to-Mini Plug adapter [B4 on instructions] to the RCA ends of your three-meter cable [B1 on instructions], converting your three-meter cable to a mini plug-to-mini plug connector. Plug one end into TV's headset socket and the other into Rocker's

mini Plug input socket. (This is same configuration as for MP3 and other portable/handheld devices.) NOTE: Audio out volume through this outlet is usually separately adjustable from speaker volume. Please consult TV's user guide for how to regulate output.

Optical Audio Out: A few models of TV only have optical audio out. If you have one of these sets, you will need an optical to cable or optical to RCA coaxial adapter, sometimes called a Toslink to RCA adapter, and some connecting cables. There are several models of adapter available at reasonable prices from general electronic retailers and HD specialist shops and web sites.

Wireless Connection

If you use the console's Component or AV cable: For direct connection to a game console, fit the mini-plug end of the B4 Mini Plug-RCA adapter to the Rocker's transmitter. Fit the RCA socket ends to the red and white audio plugs of the component or AV cable. If they are plugged into the TV, remove them, leaving the yellow video cable in place.

If you use HDMI connection to the TV: Fit the Rocker's transmitter to an available audio-out on the TV, using the appropriate connector mini-plug to mini-plug for the headset audio-out, or mini plug-to-RCA for RCA audio-out.

Other sound sources: Connect transmitter to MP3 players or handheld games using mini plug-to-mini plug connector. For other devices such as stereo amplifiers, locate the most suitable audio output. Connectors compatible with most sound sources are included with your Rocker.

TROUBLE SHOOTING

- Unable to connect to game console -

Most game consoles are shipped from the manufacturers with an Audio/Video RCA cable. The A/V RCA cable has three RCA plugs: a video plug (yellow) and two audio plugs (red and white). If your gaming console came with an A/V RCA cable, please follow the instructions supplied by the manufacturer for setting it up and connecting it to the TV. Please note that you must leave the red and white audio jacks on the A/V cable UNCONNECTED. Once the console is properly connected to your TV, please follow the diagram in the illustrated X Rocker Set-up guide to connect the gaming console to the X Rocker. If your gaming console was shipped with a coaxial cable, instead of an A/V RCA cable, you must follow an alternate set-up procedure (coaxial cable is the same type of cable that is used to connect a VCR to a TV). You will quickly recognize if your gaming console uses this type of cable. It connects the gaming console directly to the television and carries both the audio and video signal over a single cable. If your gaming console uses a coaxial cable, you CAN NOT connect it directly to the X Rocker. Instead, you must

Use an intermediary A/V device (such as a TV, VCR, DVD, TiVO, etc)

- a. Connect your gaming console to the intermediary A/V device via the coaxial cable.
- b. Connect the X Rocker to the 'Audio Out' jack on the intermediary A/V device.
- c. Follow diagram 2 in the X Rocker set-up guide to connect the X Rocker to the intermediary A/V device and finalize the setup.

If your gaming console is attached to an HD TV with an HDMI cable. You will need to connect the chair using either the audio out jacks on the back of the TV or by plugging into the headphone jack on the front of the TV.

- Unable to hear any sound from the X Rocker -

1. Check to ensure that the power adapter is properly connected to the power jack (A7). When properly connected, the indicator light (A1) on the control panel should light up when the power switch (A6) is turned on. If the indicator light (A1) does not light up, try to use another power outlet in your home. When the TX box is switched on (A12) for use in wireless mode, the power indicator light on its front panel should also light up. If the light is not on, please try changing the batteries in the TX.
2. Make sure the power unit is turned on and indicator light on the control panel is lit. If it is not, please press the power switch on the control panel. When you use wireless mode, the power indicator light on the front panel of the TX box turns green. If the light is not on, please turn on the power switch (A12) on the side. Check the BAND selector (A13) on the side of the TX box and make sure the number selected is the same as the number selected on the BAND selector (A3) of the control panel on the chair. For example, if the BAND selector on the TX box is on "1" make sure the BAND selector on the control panel is also on "1".
3. Once you have successfully completed 1. and 2. please review the X Rocker illustrated set-up guide. Double check all audio connections. Finally, check that the volume on the hand remote is turned to an audible level on both the TV and the chair.
4. If you have completed 1- 3 and still do not hear sound, try connecting another audio source (CD player, television, VCR or game console) and go through the steps again. Still not working? Help is as easy as 1,2,3:
 - 1). Please contact Ace Bayou Europe Service Center Via email Service-eu@acebayou.com.
 - 2). Call +44(0)845 468 0262 to request assistance.
 - 3). Please go to for answers to frequently asked questions.

WARRANTY PAGE

Limited Warranty:

Ace Bayou warrants this product (including any accessories) against defects in material and workmanship for a period of 90 days from the date of purchase. This warranty is enforceable only by the original purchaser.
ALL DAMAGED OR MISSING PARTS MUST BE REPORTED WITHIN 14 DAYS OF PURCHASE.

This warranty covers all defects in material and workmanship in this product, but DOES NOT COVER the following:

1. Damage, deterioration or malfunction resulting from:
 - a. Acts of God, accident, misuse, abuse, negligence, improper installation, maintenance or operation, or failure to follow the instructions contained in this owner's manual.
 - b. Any damage in the shipment of the product. (Claims must be presented to the carrier.)
 - c. Repair, attempted repair, or modifications by anyone other than the Ace Bayou Service Center.
2. Any unit which has been modified or attempted to be modified or altered in any way whatsoever.
3. Normal wear and periodic maintenance.
4. Any unit used for industrial or commercial purposes (including rental).
5. Products sold AS IS or WITH ALL FAULTS, or consumables (such as fuses, batteries, etc)
6. Customer installation, set up adjustments, or signal reception problems.

Ace Bayou will repair or replace (at its discretion) units covered by this warranty without charge to the consumer for labor or materials. YOU ARE RESPONSIBLE FOR INITIAL SHIPPING CHARGES. However, we will pay the return shipping charges to any destination within the European Union if repairs are covered by the warranty.

REPAIR OR REPLACEMENT AS PROVIDED UNDER THIS WARRANTY IS THE EXCLUSIVE REMEDY OF THE CONSUMER. ACE BAYOU SHALL NOT BE LIABLE FOR ANY INCIDENTAL OR CONSEQUENTIAL DAMAGES FOR BREACH OF ANY EXPRESSED OR IMPLIED WARRANTY ON THIS PRODUCT. EXCEPT TO THE EXTENT PROHIBITED BY APPLICABLE LAW, ANY IMPLIED WARRANTIES, INCLUDING WARRANTIES OF MERCHANTABILITY AND FITNESS FOR A PARTICULAR PURPOSE, ARE LIMITED IN DURATION TO THE LENGTH OF THIS WARRANTY.

This device complies with Part 15 of the FCC Rules. Operation is subject to the following two conditions:

1. This device may not cause harmful interference.
2. This device must accept any interference received, including interference that may cause undesired operation.

DO NOT SHIP ANYTHING TO US WITHOUT CONTACTING US FIRST. DO NOT SHIP ANY PARTS OR WHOLE UNITS TO THIS ADDRESS FOR REPAIR WITHOUT OUR PERMISSION.

In Europe	In North America
Ace Bayou EU +44 (0)845 468 0262 Email: service-eu@acebayou.com	Ace Bayou Corp PO Box 1853 Lewisburg, TN 37091 1-866-969-2603 or 931-359-2603 Email: service@acebayou.com

Need Help? Email: service@acebayou.com Web: www.thexrocker.com
Phone: 1 931 359 2603, In Europe, call +44 (0)845 468 0262